

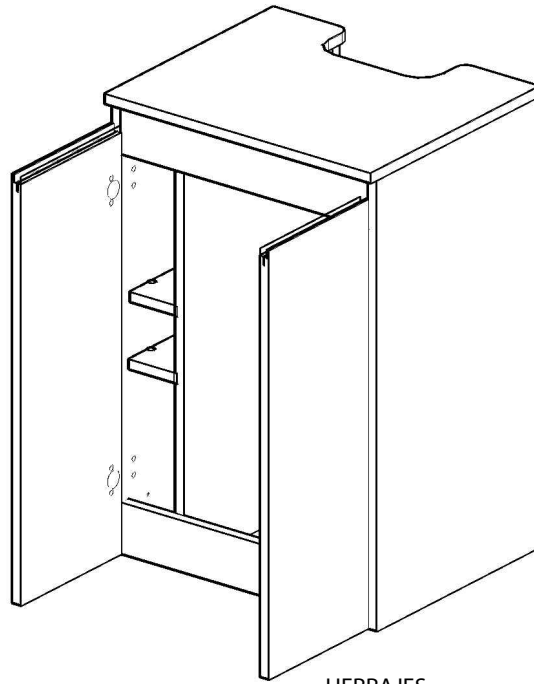

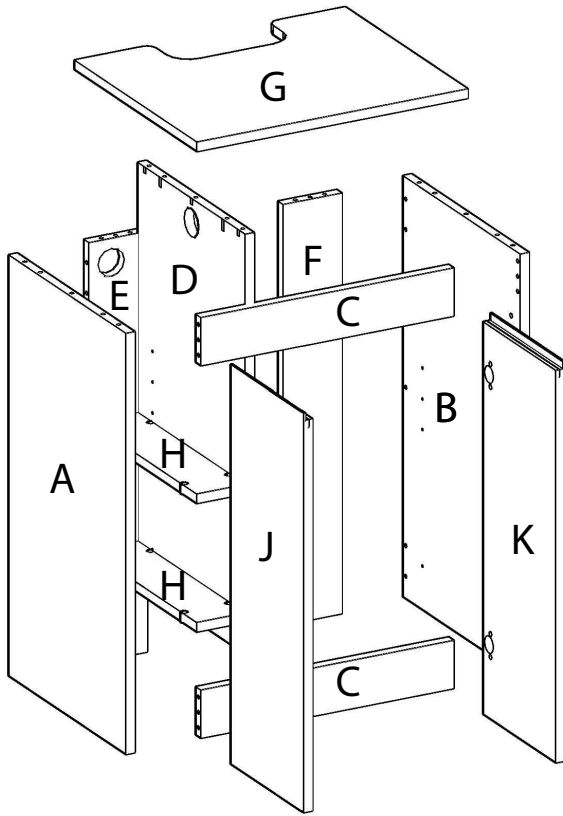





MANUAL DE MONTAJE MESA A60 PARA MARINOS

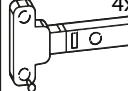

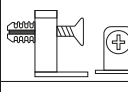
HERRAJES

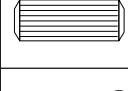
	16x	TRIPLO BLANCO [PIE NIVELADOR] - 9030.80
	4x	BISAGRA RECTA ACERO INOX [AMORTIGUADA] [CON TACO Ø10] 644.270
	4x	BASE BISAGRA ACERO INOX H0 [CON TACO Ø10] -644.416
	2x	KINO Ø60 BLANCO [PASACABLES] - 701.8
		MAORI 19mm [CAZOLETA] - 504.155
	8x	MAORI 19mm [SOPORTE CON TACO] - 504.204
	16x	MINA 5 [TAPA EMBELLECEDORA BLANCA] - 573.17
	16x	COHIBA [ESPIGA Ø8x30] - 984.113
	30x	CONECTOR SC 8/25 - 262.11.111(HAFELE)

ADVERTIMOS QUE SIGA ESTRICTAMENTE LAS INSTRUCCIONES DE MONTAJE DADO QUE SU INSTALACIÓN TOTALMENTE ESTANCA IMPIDE DESMONTARSE POSTERIORMENTE

Costado Derecho

Costado Izquierdo

Barra CT 2x

Tapa CT^C

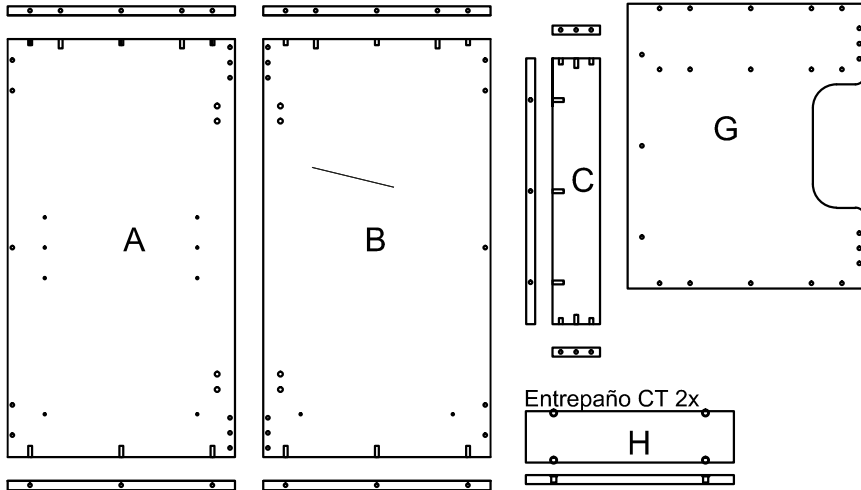

Division CT

Trasera izq Trasera der Puertas

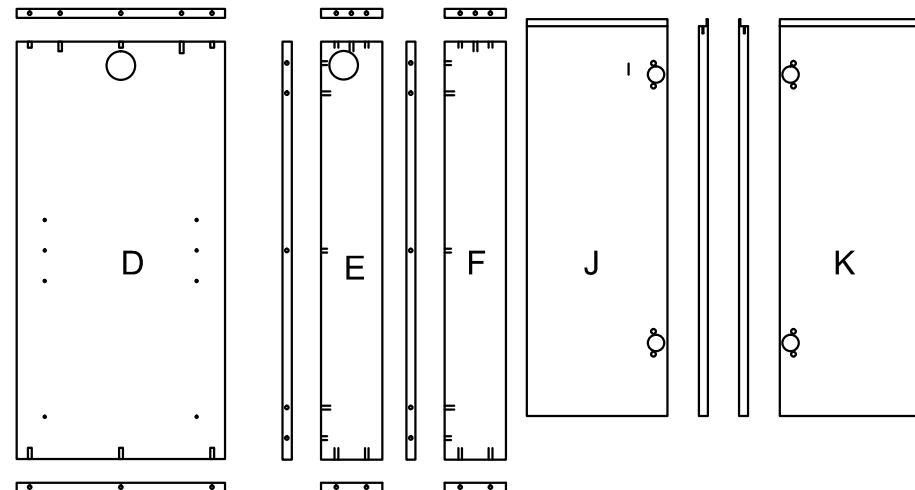

A	Costado Derecho	x1
B	Costado Izquierdo	x1
C	Barra superior e inferior	x2
D	División	x1
E	Trasera izquierda	x1

F	Trasera derecha	x1
G	Tapa	x1
H	Entrepañó	x2
I	Puerta izquierda	x1
J	Puerta derecha	x1

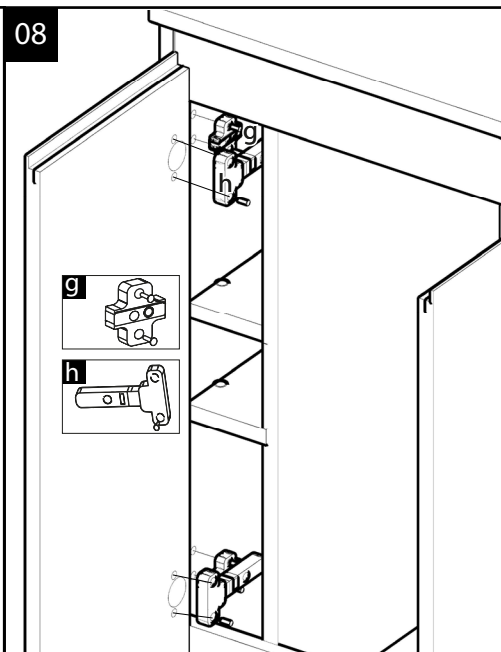
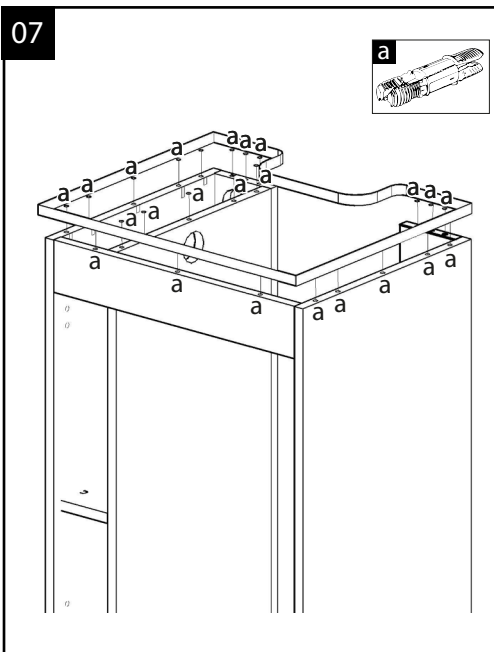
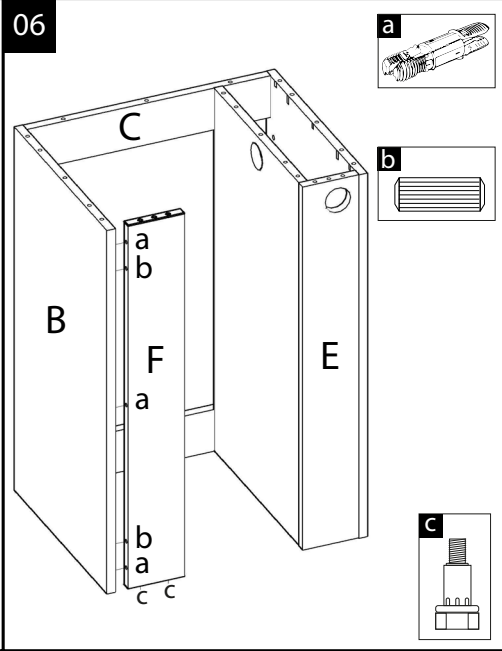
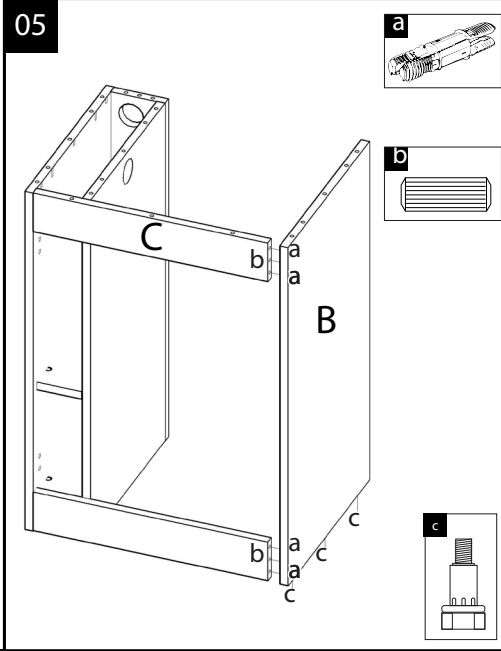
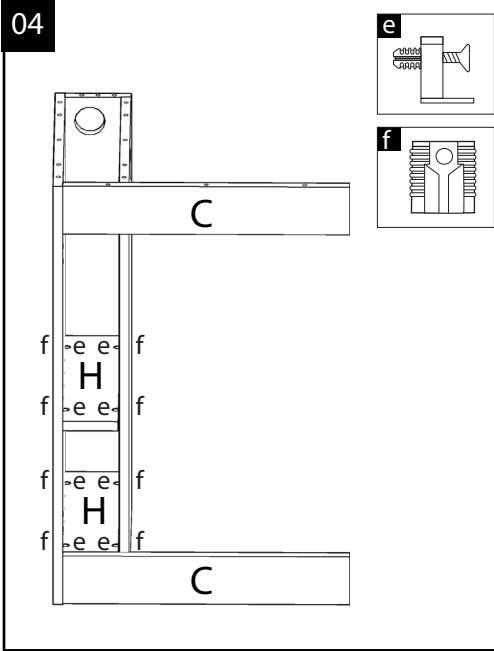
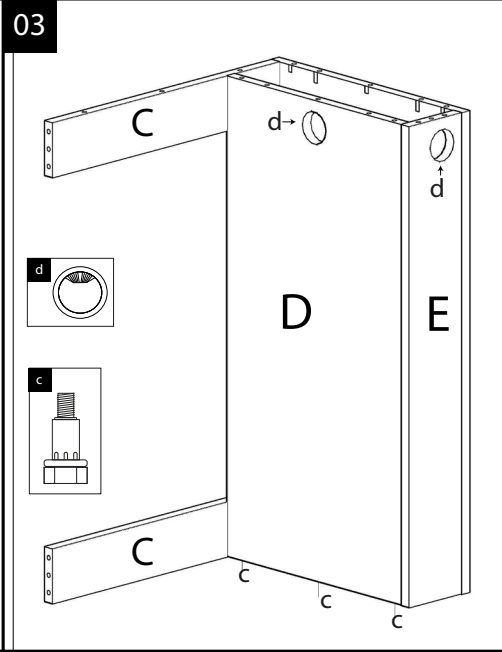
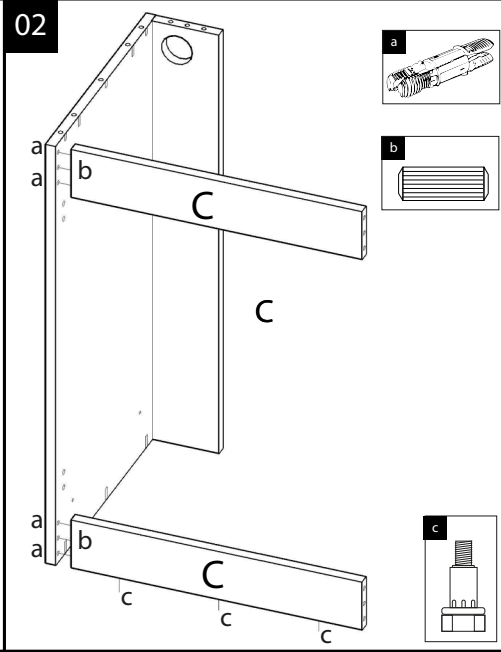
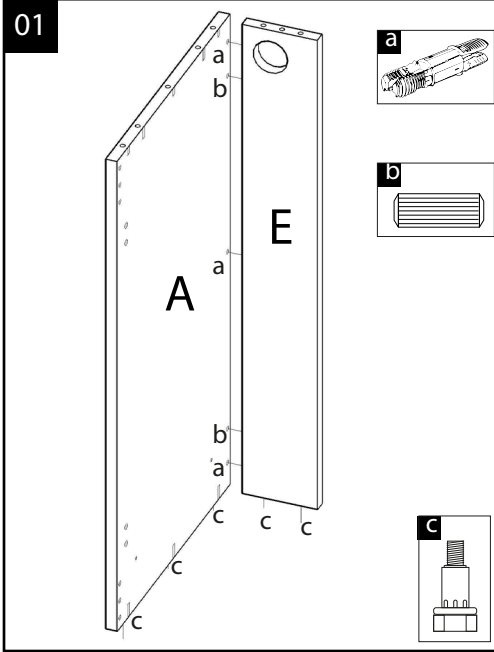

IMPORTADO Y DISTRIBUIDO POR: ICA, S.A.
 C.I.F.: A-35031343
 Avda. de la Constitución, Parcela 242 a
 247, Pol. Ind. Monte Boyal 45950 -
 CASARRUBIOS DEL MONTE (Toledo)
 España www.icasa.com
 Toledo (+34) 918 170 001