



Montaje mesa de madera modelo: **AQUALIGHT**

Referencia: **M100120**

Mesa con 2 Puertas

Puertas

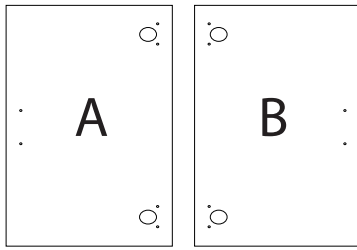

Laterales

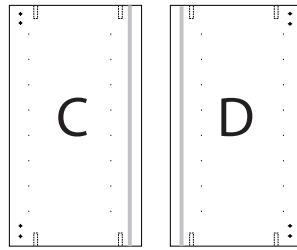

Traseras

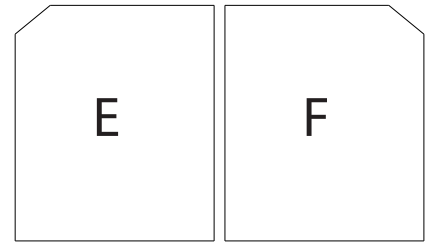

(Fijadas a la separación mediante grapillas metálicas)

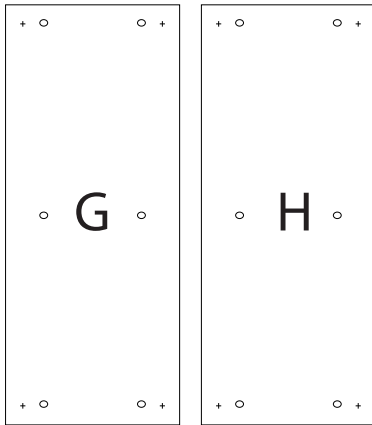

Base

Techo

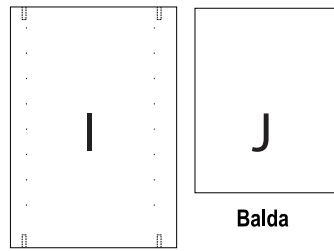

Separación

Balda

Accesorios

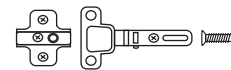

4 Bisagras + tornillos



4 Patas

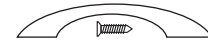

2 Tiradores puerta + tornillos



4 Posa baldas



Grapillas metálicas
(Unión de traseras)



Tornillos rosca madera con tapón



10 Tapones



12 Espigas de madera

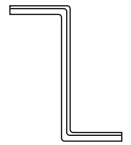

Llave de montaje

NOTA: Base y techo intercambiables, selección de los dos el que coincida con su modelo de acuario.

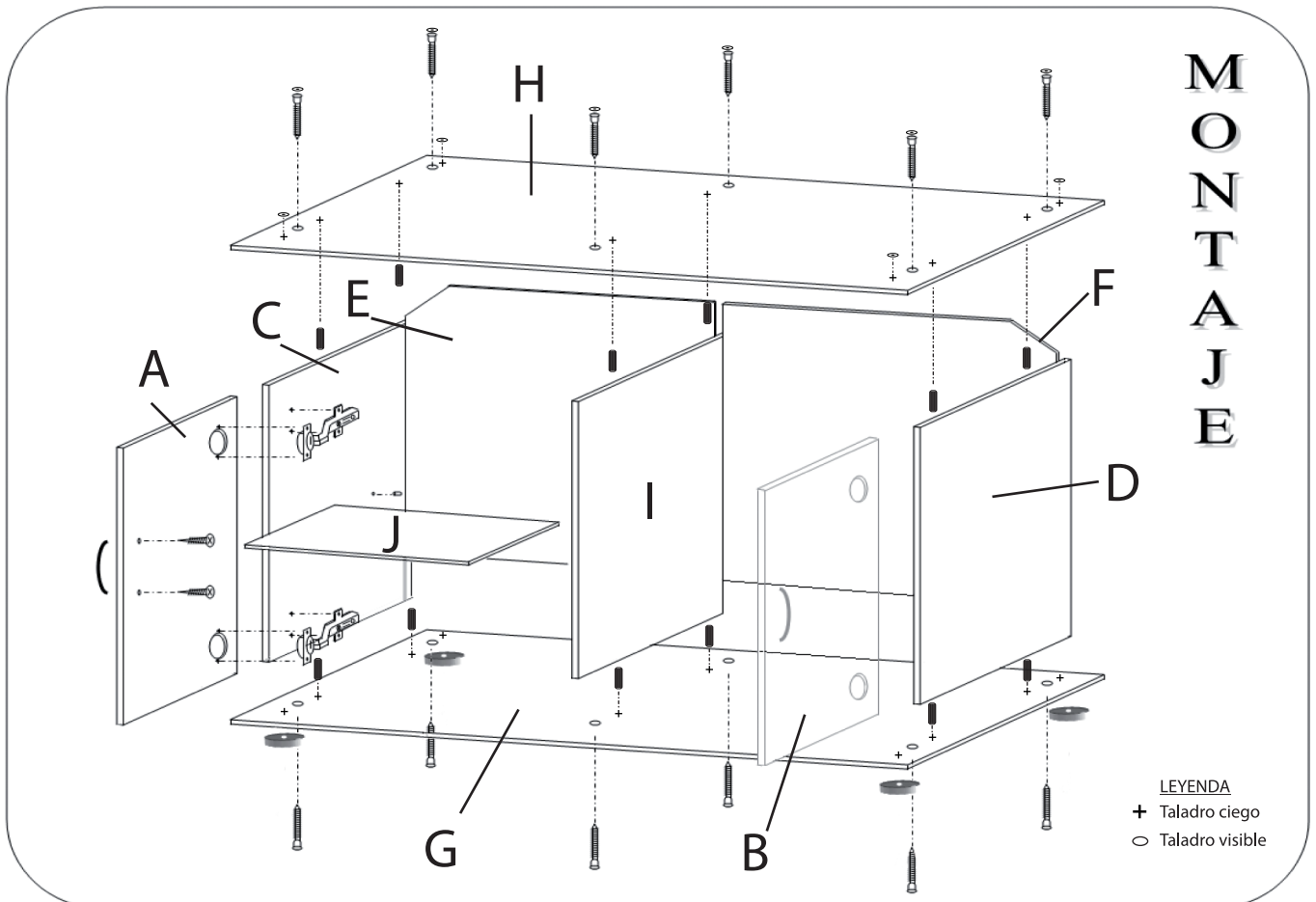

MONTAJE

LEYENDA

- + Taladro ciego
- o Taladro visible