

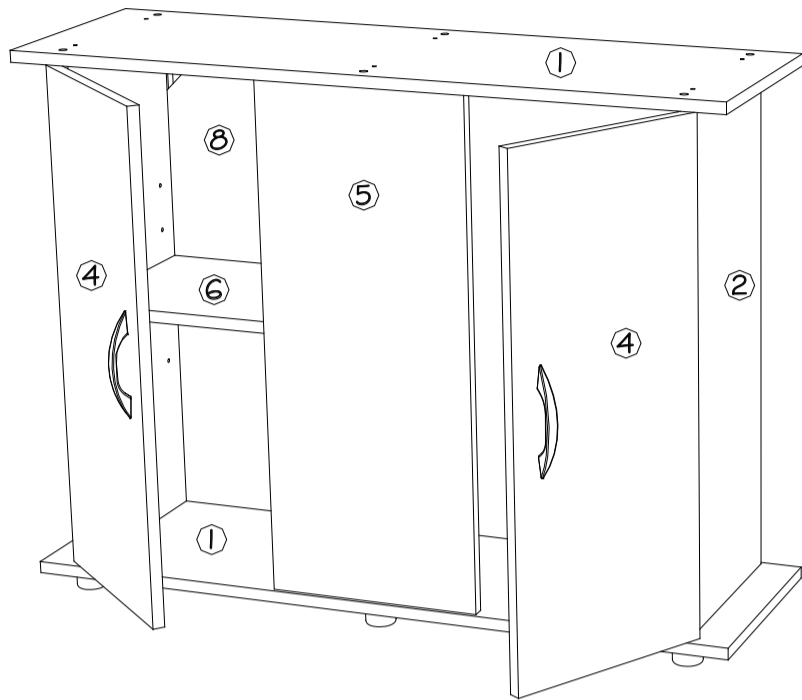

AQUA-LIGHT-LED-LUX

Montaje mesa de madera modelo:
referencia: M168200



Herramientas necesarias para el montaje

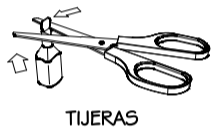

TIJERAS

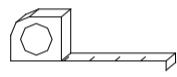

CINTA METRICA



DESTORNILLADOR

Nota: Fondo y techo intercambiables, seleccione de los dos el que coincida con su modelo de acuario.

Composicion de piezas

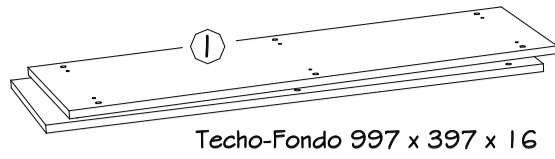

Techo-Fondo 997 x 397 x 16

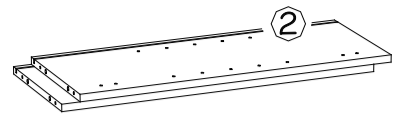

Costado 698 x 370 x 16

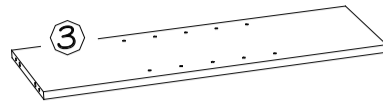

Costado Interno 698 x 352 x 16

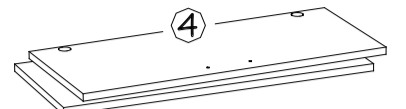

Puerta 692 x 293 x 16



Frontal 698 x 293 x 16



Entrepañó Movil 418 x 352 x 16



Trasera Derecha 698 x 435 x 3

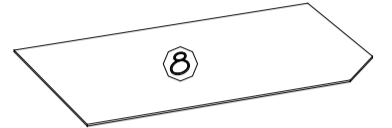

Trasera Izquierda 698 x 435 x 3

Composicion de herrajes

| | | | | | |
|--|-----|--|-----|--|-----|
| | (A) | | (F) | | (K) |
| | 2 | | 12 | | 35 |
| | (B) | | (G) | | (L) |
| | 4 | | 1 | | 6 |
| | (C) | | (H) | | (M) |
| | 4 | | 16 | | 6 |
| | (D) | | (I) | | (O) |
| | 6 | | 4 | | 3 |
| | (E) | | (J) | | |
| | 1 | | 4 | | |

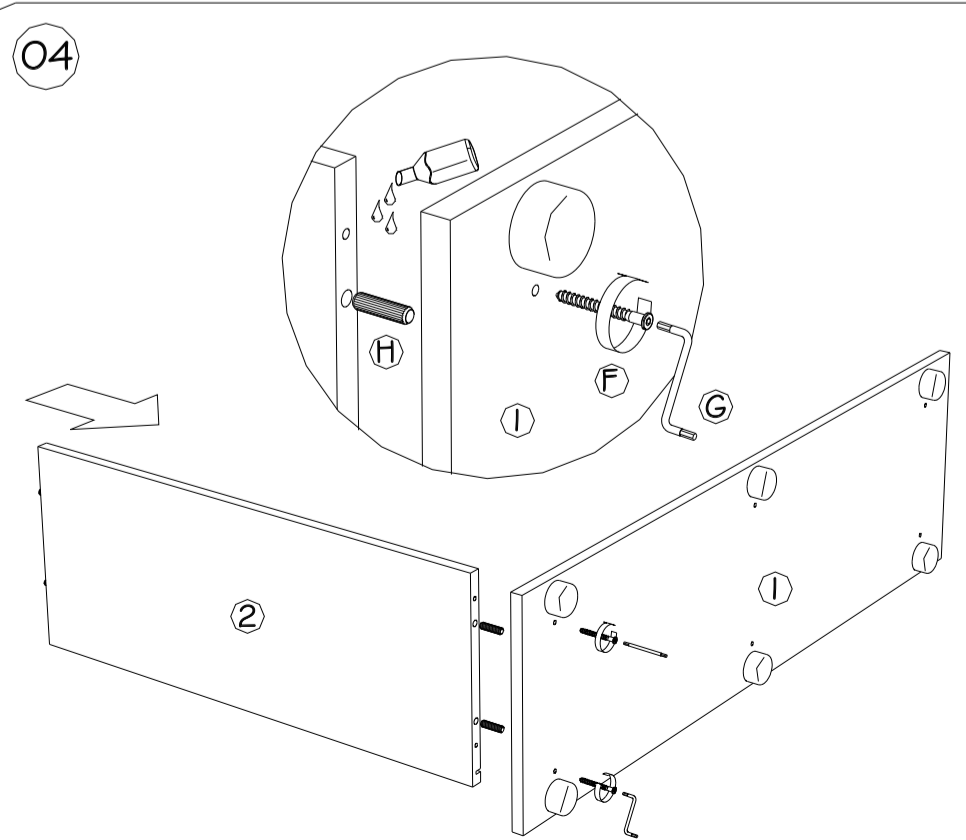
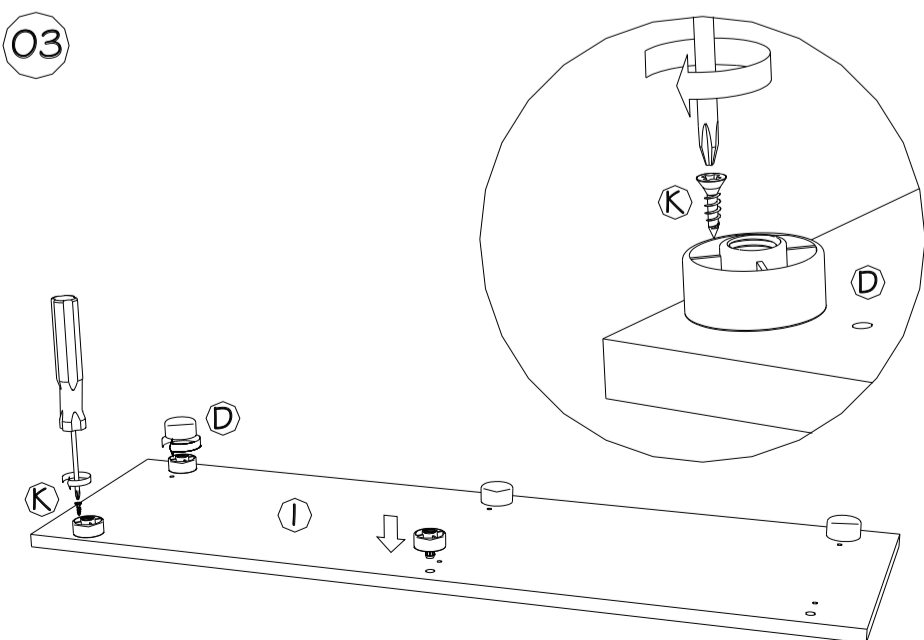
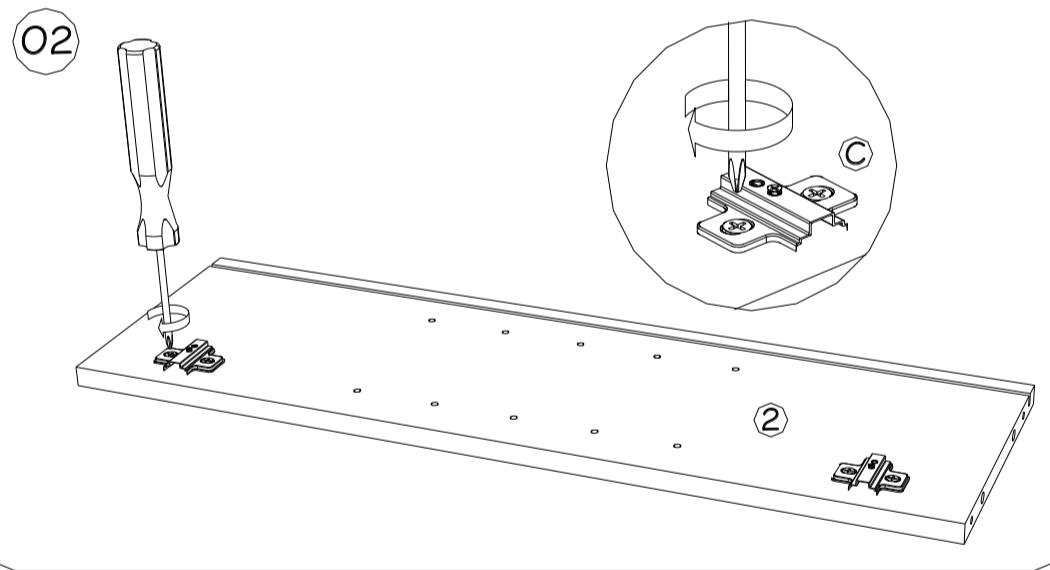
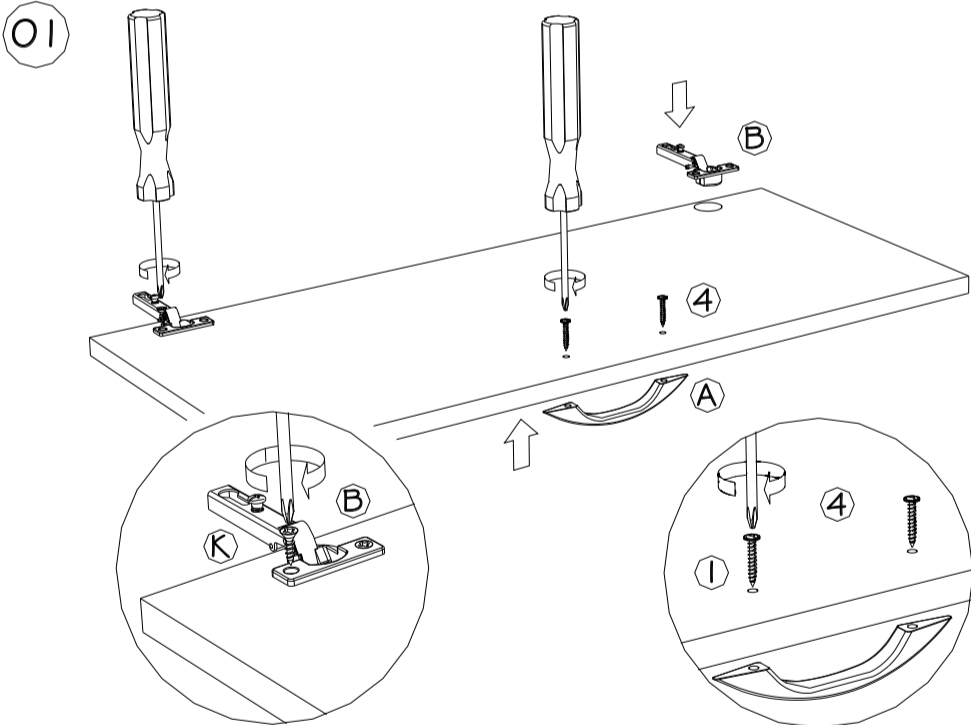

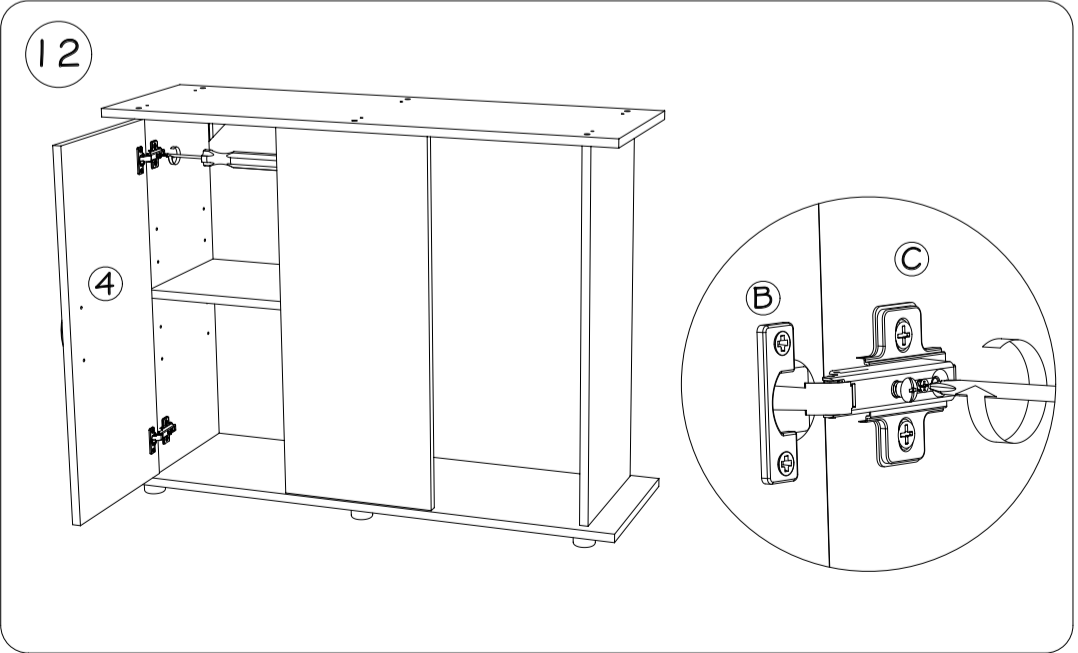
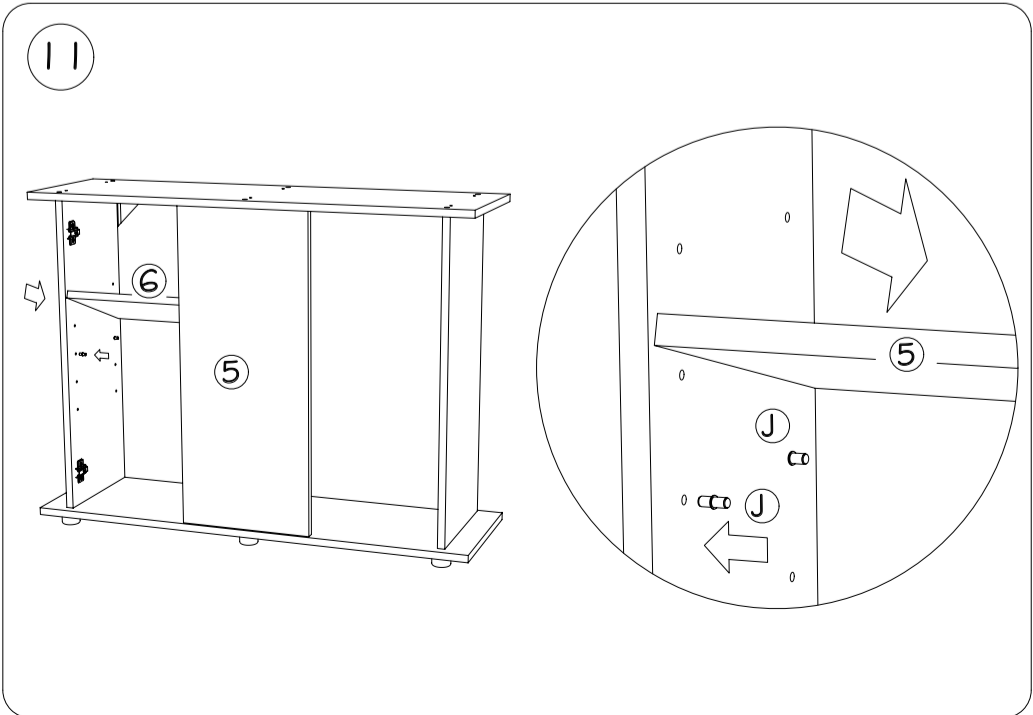
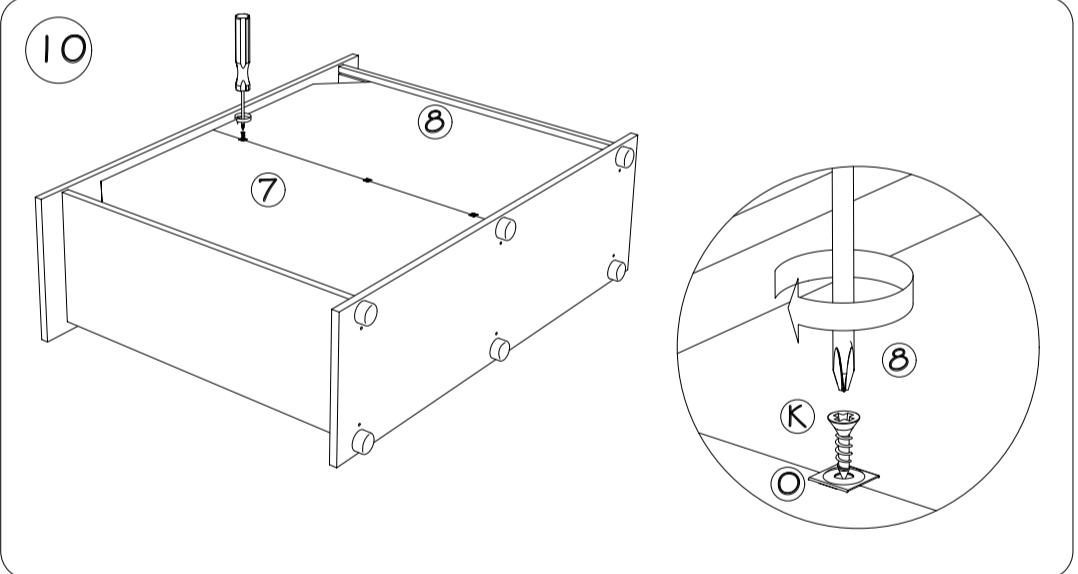
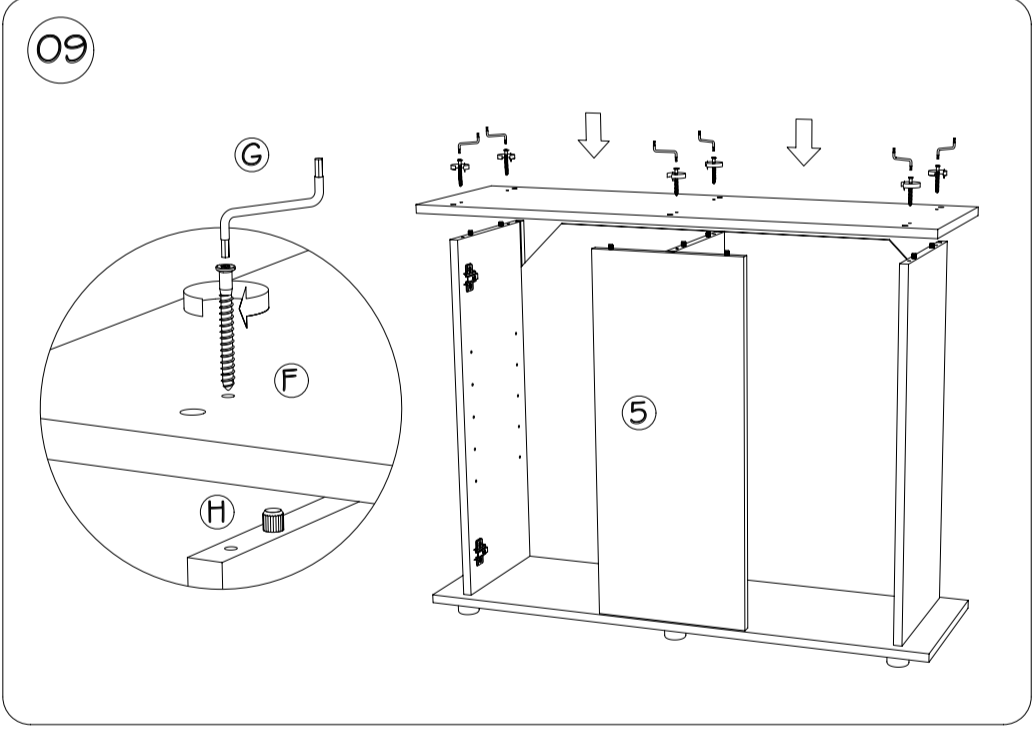
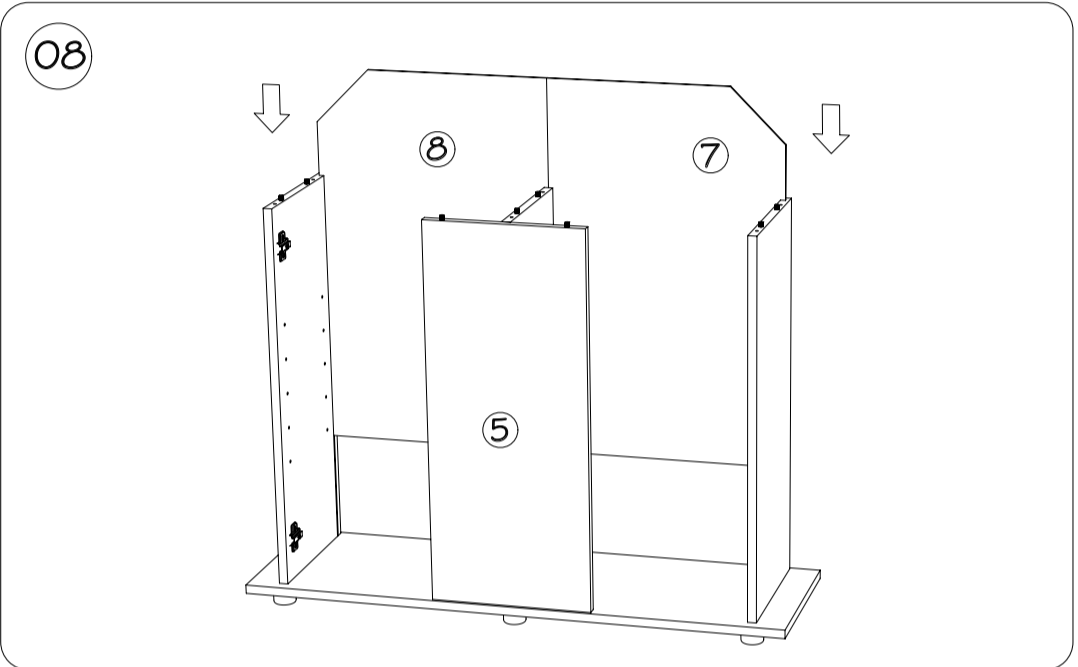
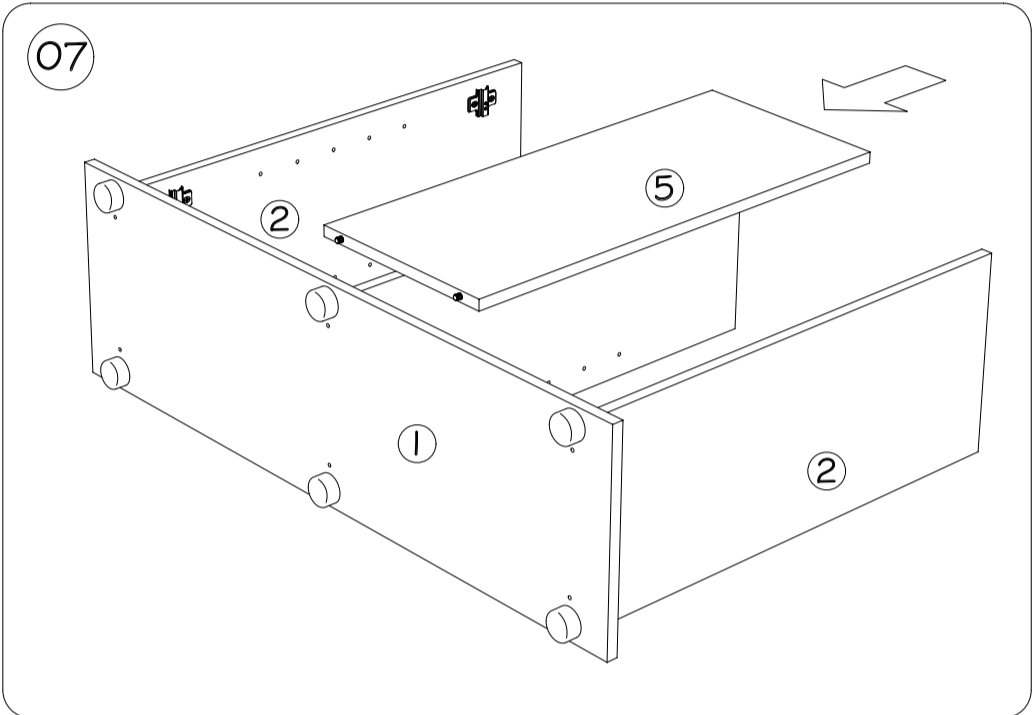
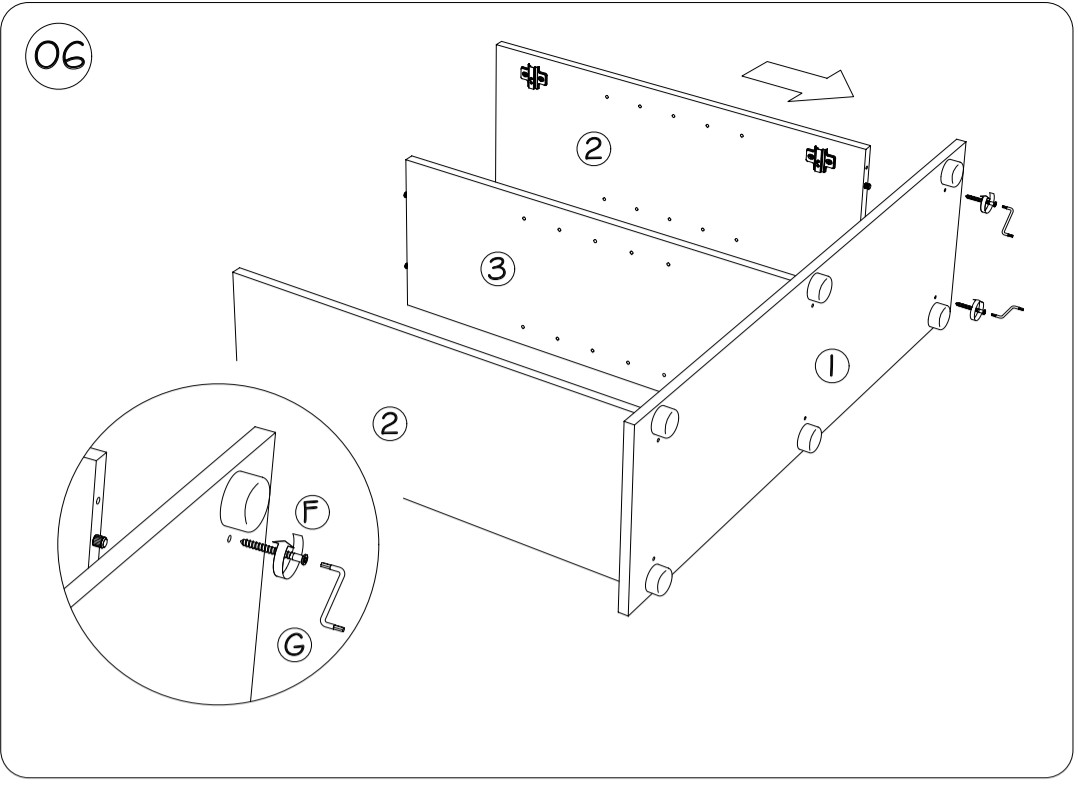
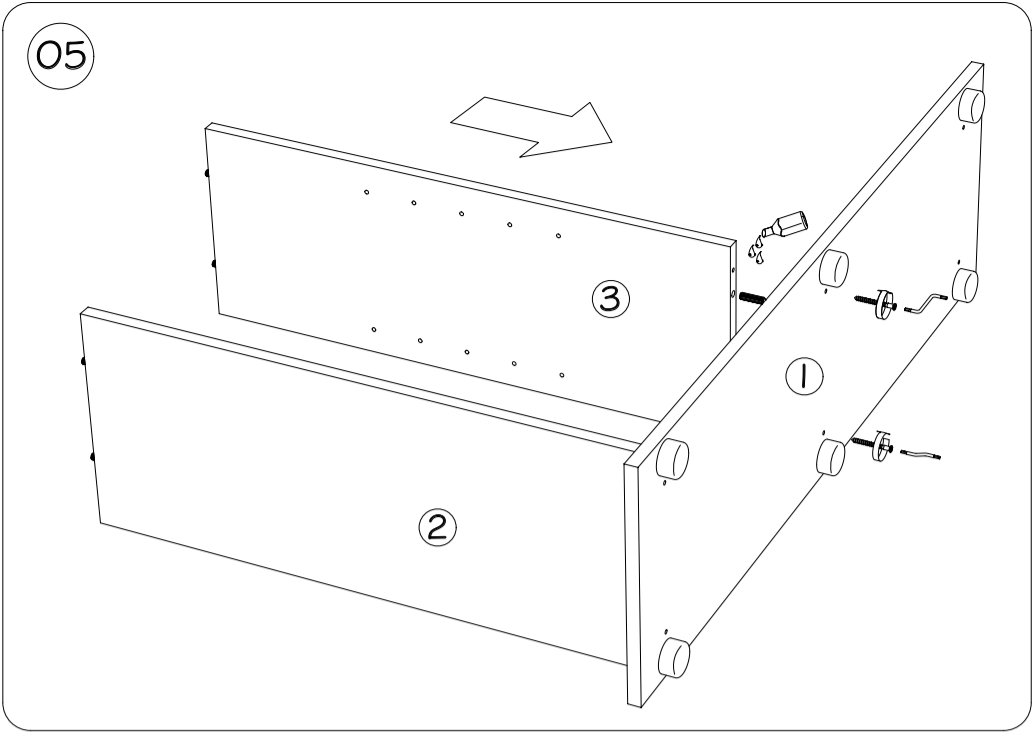

DISTRIBUÍDO POR: ICA, S.A. - Avda. de la Constitución, Parcela 242 a 247,
 Pol. Ind. Monte Boyal 45950 CASARRUBIOS DEL MONTE (Toledo) España
 - Toledo (+34) 918 170 001 - Barcelona (+34) 933 034 335
 - Canarias (+34) 928 714 422 - Portugal (+351) 219 240 448 - www.icasa.com